

User Manual



EnStation2
version 1.0

N300 2.4GHz Long Range Point to Point CPE

TABLE OF CONTENTS

Conventions	0-vii
Copyright	0-ix

Product Overview

Package Contents	1-1
Product Overview	1-2
Key Features	1-2
Benefits	1-3
Technical Specification	1-4
Wireless Specification	1-4
Hardware Specification	1-4
Software Specification	1-4
Product Interface	1-5

Installation

System Requirements	2-1
---------------------	-----

Installing the Device	2-2
Pre-Installation Guidelines	2-2
Installing the Device	2-2
Wall Mounting the Device	2-3
Pole Mounting the Device	2-4

Web Configuration

Logging In	3-1
Best Practices	3-2

Basic Network Settings

System Status	4-1
Using Save/Reload	4-1
Viewing System Information	4-2
Viewing Wireless Client List	4-4
Viewing System Log	4-5
Viewing Connection Status	4-6
Viewing DHCP Client Table	4-7

Viewing WDS Link List	4-8
System Setup	4-9
Configuring Operation Mode	4-9
Configuring IP Settings	4-10
Configuring Spanning Tree Settings	4-11
Router Setup	4-12
Configuring WAN Settings	4-12
Static IP	4-12
Dynamic IP	4-13
Point-to-Point Protocol over Ethernet (PPPoE)	4-14
Point-to-Point Tunnelling Protocol (PPTP)	4-15
Configuring LAN Settings	4-17
Configuring VPN Pass-Through	4-18
Configuring Port Forwarding	4-19
Configuring Demilitarized Zone	4-21
Configuring Wireless LAN	4-22
Configuring Wireless Settings	4-22
Access Point Mode	4-22
Client Bridge Mode	4-24
WDS Bridge Mode	4-26

Client Router Mode	4-28
Configuring Wireless Security	4-30
Wired Equivalent Privacy (WEP)	4-30
Wi-Fi Protected Access Pre-Shared Key (WPA-PSK)	4-31
Wi-Fi Protected Access 2 Pre-Shared Key (WPA2-PSK)	4-32
Wi-Fi Protected Access Pre-Shared Key (WPA-PSK) Mixed	4-33
Wi-Fi Protected Access (WPA)	4-34
Wi-Fi Protected Access 2 (WPA2)	4-35
Wi-Fi Protected Access (WPA) Mixed	4-36
Configuring Wireless MAC Filter	4-37
Configuring WDS Link Settings	4-38
Configuring Advanced Network Settings	4-39
Wireless Traffic Shaping	4-39
Management Setup	4-40
Configuring Administrator Account	4-40
Configuring Management VLAN	4-41
Configuring SNMP	4-42
Configuring Backup/Restore Settings	4-44
Configuring Auto Reboot Settings	4-45
Configuring Firmware Upgrade	4-46

Configuring System Time	4-47
Configuring Wi-Fi Schedule	4-48
Add a Schedule Service	4-48
Schedule Services Table.	4-49
Configuring Command Line Interface	4-50
Configuring Logging	4-51
Configuring Diagnostics	4-52
Viewing Device Discovery	4-53
Configure Denial of Service Protection	4-54
Logging Out	4-55

Appendix A

Federal Communication Commission Interference Statement	A-1
---	-----

Appendix B

Europe – EU Declaration of Conformity	B-1
---------------------------------------	-----

Appendix C

WorldWide Technical Support	C-1
-----------------------------	-----

Conventions

The following conventions are used to give the user additional information about specific procedures or content. It is important to pay attention to these conventions as they provide information to prevent damage to equipment or personal injury.

General Conventions

The following general conventions are used in this document.



CAUTION!

CAUTIONS APPEAR BEFORE THE TEXT IT REFERENCES. CAUTIONS APPEAR IN CAPITAL LETTERS TO EMPHASIZE THAT THE MESSAGE CONTAINS VITAL HEALTH AND SAFETY INFORMATION.



WARNING!

Warning information appears before the text it references to emphasize that the content may prevent damage to the device or equipment.



Important:

Indicates information that is important to know for the proper completion of a procedure, choice of an option, or completing a task.



Note:

Indicates additional information that is relevant to the current process or procedure.



Example:

Indicates information used to demonstrate or explain an associated concept.

N/A:

Indicates that a component or a procedure is not applicable to this model.

Prerequisite:

Indicates a requirement that must be addressed before proceeding with the current function or procedure.

Typographical Conventions

The following typographical conventions are used in this document:

Italics

Indicates book titles, directory names, file names, path names, and program/process names.

Constant width

Indicates computer output shown on a computer screen, including menus, prompts, responses to input, and error messages.

Constant width bold

Indicates commands lines as entered on the computer. Variables contained within user input are shown in angle brackets (< >).

Bold

Indicates keyboard keys that are pressed by the user.

Copyright

This user guide and its content is copyright of © EnGenius Networks, 2014. All rights reserved.

Any redistribution or reproduction in part or in whole in any form is prohibited.

Do not distribute, transmit, store in any form of electronic retrieval system or commercially exploit the content without the expressed written permission of EnGenius Networks.

Product Overview

Chapter 1

1.1 Package Contents

- The EnStation package contains the following items:
- EnStation
- PoE Injector with Power Adapter
- 24V PoE Injector
- Quick Installation Guide
- Mounting Screw Set
- Wall Mount Kit
- Pole Mount Strap

1.2 Product Overview

Thank you for choosing EnStation2. The EnStation2 is a long range, high performance IEEE 802.11b/g/n network solution that provides Access Point, Client Bridge, WDS, and Client Router functions in a single device.

In addition to providing the latest wireless technology, the EnStation2 supports Power over Ethernet and Power by Adapter capabilities, which allow the device to be installed easily in nearly any indoor or outdoor location. Advanced features include power level control, traffic shaping, and Real time RSSI indication.

A variety of security features help to protect your data and privacy while you are online. Security features include Wi-Fi Protected Access (WPA PSK/WPA2 PSK), 64/128/156 bit WEP Encryption, and IEEE 802.1x with RADIUS.

Key Features

- High-speed data rates up to 300 Mbps make the EnStation2 ideally suited for handling heavy data payloads such as MPEG video streaming
- High output power up to 26 dBm delivers superior range and coverage
- Fully Interoperable with IEEE 802.11b/IEEE 802.11g/IEEE 802.11n-compliant devices
- Multi-function capabilities enable users to use different modes in various environments

- Point-to-point and point-to-multipoint wireless connectivity enable data transfers between two or more buildings
- Channel bandwidth selection allows the appropriate bandwidth to be used to reach various distances
- RSSI indicator makes it easy to select the best signal for Access Point connections
- Power-over-Ethernet capabilities allow for flexible installation locations and cost savings
- Four SSIDs let clients access different networks through a single Access Point, and assign different policies and functions for each SSID
- WPA2/WPA/ WEP/ IEEE 802.1x support and MAC address filtering ensure secure network connections
- PPPoE/PPTP function support make it easy to access the Internet via Internet Service Provider (ISP) service authentication
- SNMP Remote Configuration Management helps administrators remotely configure or manage the Access Point
- QoS (WMM) support enhances performance and user experiences

Benefits

The EnStation2 is the ideal product around which you can build your WLAN. The following list summarizes a few key advantages that WLANs have over wired networks:

Ideal for hard-to-wire environments

There are many scenarios where cables cannot be used to connect networking devices. Historic and older buildings, open areas, and busy streets, for example, make wired LAN installations difficult, expensive, or impossible.

Temporary workgroups

WLANs make it easy to provide connectivity to temporary workgroups that will later be removed. Examples include parks, athletic arenas, exhibition centers, disaster-recovery shelters, temporary offices, and construction sites.

Ability to access real-time information

With a WLAN, workers who rely on access to real-time information, such as doctors and nurses, point-of-sale employees, mobile workers, and warehouse personnel, can access the data they need and increase productivity, without having to look for a place to plug into the network.

Frequently changed environments

WLANs are well suited for showrooms, meeting rooms, retail stores, and manufacturing sites where workplaces are rearranged frequently.

Wireless extensions to Ethernet networks

WLANs enable network managers in dynamic environments to minimize overhead caused by moves, extensions to networks, and other changes.

Wired LAN backup

Network managers can implement WLANs to provide backup for mission-critical applications running on wired networks.

Mobility within training/educational facilities

Training sites at corporations and students at universities are a few examples where wireless connectivity can be used to facilitate access to information, information exchanges, and learning.

Technical Specification

Wireless Specification

- IEEE802.11b/g/n, 2T2R, 300Mbps
- 2.400 to 2.484 GHz

Hardware Specification

- Physical Interface: 2 x 10/100Mbps LAN Ports, 1 x Reset Button
- Power Supply: Passive PoE, 24V/0.6A Power Adapter
- Dimension: 190(D)x38mm(H)
- Operation Temperature: -20°C ~ 60°C
- Embedded high gain directional antenna

Software Specification

- Operation Mode: Client Bridge, Access Point, Client Router, WDS AP, WDS Bridge, WDS Station
- Multiple SSID, Preferred SSID
- PPPoE, PPTP, L2TP Pass-through
- WMM, Traffic Shaping
- CLI Interface, SNMP v1/v2c/v3
- Recovery Page
- Port Forwarding/DMZ
- Narrow Bandwidth

1.3 Product Interface

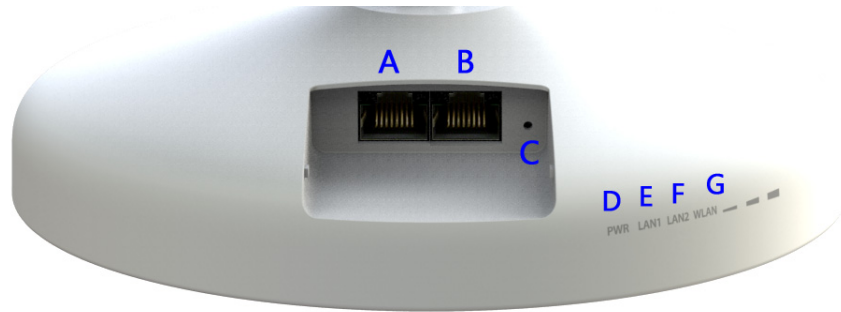

Figure 1-1: Back Panel View

BACK PANEL VIEW		DESCRIPTION
A	LAN Port(PoE)	The PoE interface allows EnStation to be powered using the supplied PoE injector
B	LAN Port	To configure EnStation, connect to an Ethernet adapter in a computer for accessing more information
C	Reset Button	To reset factory settings, press button more than 10seconds.
D	Power LED	OFF=EnStation is not receiving power ON=EnStation is receiving power
E	LAN(2) LEDs	OFF=EnStation is not connected to the network ON=Enstation is connected to the network but not sending or receiving data

BACK PANEL VIEW		DESCRIPTION
F	WAN LED	(Access Point or Client Bridge Mode) OFF=EnStation radio is off and the device is not sending or receiving data over the wireless LAN ON=EnStation radio is on, and the device is not sending or receiving data over the wireless LAN. Blinking=EnStation radio is on, and the device is sending or receiving data over the wireless LAN.
G	Signal Indicator LED	(Client Bridge, WDS Station and Client Router Mode)

Installation

Chapter 2

2.1 System Requirements

To install the EnStation2, you need the following:

- Computer (Windows, Linux, Mac OS X Operating System)
- Web Browser (Internet Explorer, FireFox, Chrome, Safari)
- Network Interface equipped: (one of the following)
 - **Wired connectivity:** Network Interface with an open RJ-45 Ethernet Port
 - **Wireless Connectivity:**
 - Embedded 802.11n Wi-Fi wireless networking, IEEE 802.11b/g compatible
 - Wi-Fi Card, USB Wi-Fi Dongle (802.11 b/g/n)
- An existing router or access point (AP) with SSID broadcast
- 1x CAT5e Ethernet Cable

2.2 Installing the Device

Installing the EnStation2 on a pole or wall optimizes the wireless access range.

**Note:**

Only experienced installation professionals who are familiar with local building and safety codes and, wherever applicable, are licensed by the appropriate government regulatory authorities should install the EnStation2.

Pre-Installation Guidelines

Select the optimal location for the equipment using the following guidelines:

- The EnStation2 should be mounted on a 1"-4" pole. Its location should enable easy access to the unit and its connectors for installation and testing.
- The higher the placement of the antenna, the better the achievable link quality.
- The antenna should be installed to provide a direct, or near line of sight with the Base Station antenna. The antenna should be aligned to face the general direction of the Base Station.

Installing the Device

To install the EnStation2, use the following procedure to mount the device on a pole and refer to the figure below.

1. Remove the bottom cover protecting the RJ-45 connectors.
2. Insert an Ethernet cable into the RJ-45 port labeled LAN.
3. Install the bottom cover to protect the RJ-45 connectors.
4. Remove the power cord and PoE injector from the box and plug the power cord into the DC port of the PoE injector.

**CAUTION!**

ONLY USE THE POWER ADAPTER SUPPLIED WITH THE ENSTATION2. USING A DIFFERENT POWER ADAPTER MIGHT DAMAGE THE ENSTATION2.

5. Plug the other end of the Ethernet cable into the PoE port of the PoE injector.

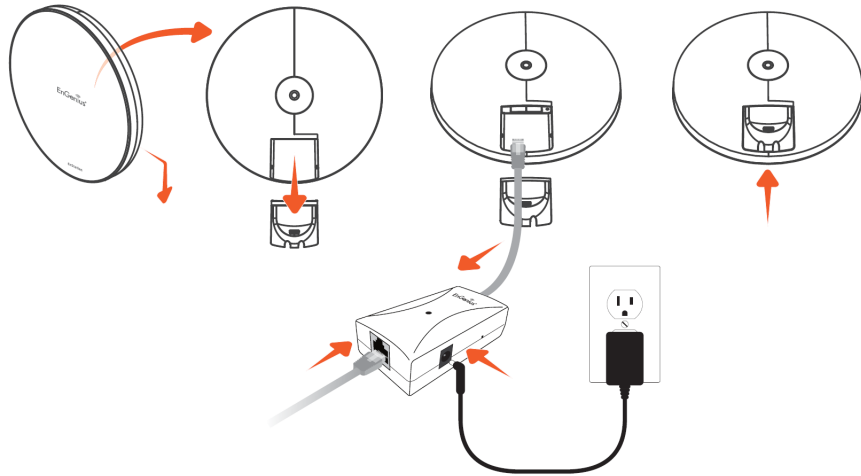

Figure 2-1: Installing the EnStation2

6. Turn over the EnStation2. Then insert the pole mounting strap through the middle hole of the EnStation2. Use a screwdriver to unlock the pole-mounting ring putting it through the EnStation2.
7. Mount the EnStation2 securely to the pole by locking the strap tightly.

This completes the installation procedure.

Wall Mounting the Device

1. Plug the dynamic stick into the bracket firstly.
2. Combine the sealing nut and the assembled kit, as well as tighten it.
3. Put the mock washer on dynamic stick.
4. Assemble the mounting kit with the CPE.
5. Drill the hole to input the mounting screws.
6. Use the included screws to input the mounting screws.
7. Let the hole of the bracket to aim at the screws on the wall and hang the device to fix it.

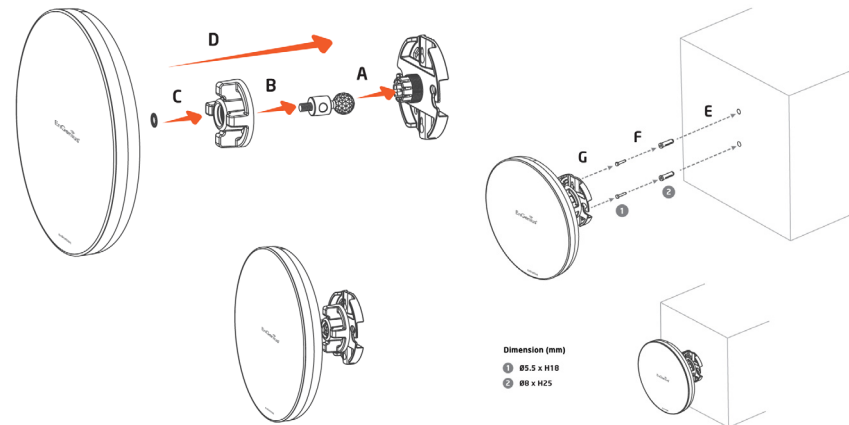

Figure 2-2: Wall Mounting the Device

Pole Mounting the Device

1. Plug the dynamic stick into the bracket firstly.
2. Combine the sealing nut and the assembled kit, as well as tighten it.
3. Put the mock washer on dynamic stick.
4. Assemble the mounting kit with the CPE.
5. Thread the open end of the pole strap through the two tabs on the bracket.
6. Lock and tighten pole strap to secure bracket to the pole.

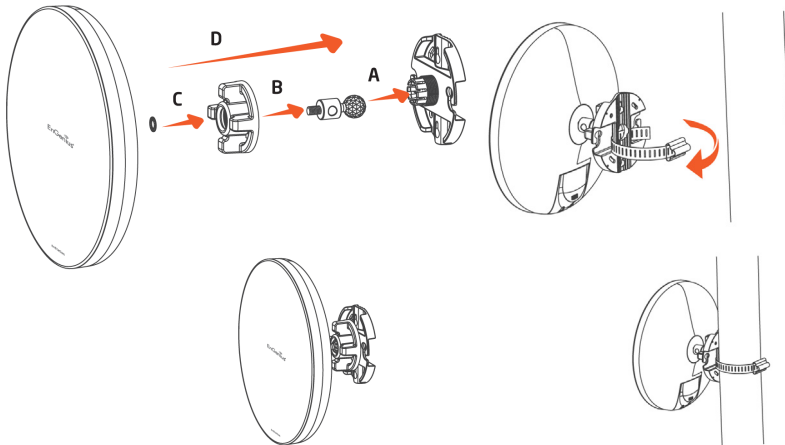

Figure 2-3: Pole Mounting the Device

Web Configuration

Chapter 3

3.1 Logging In

The EnStation2 has a built-in Web Configurator that lets you manage the unit from any location using a Web browser that supports HTTP and has Javascript installed.

After configuring the computer for TCP/IP using the procedure appropriate for your operating system, use that computer's Web browser to log in to the EnStation2 Web Configurator.

1. Launch your Web browser.
2. In the browser address bar, type `192.168.1.1` and press the Enter key.

**Note:**

If you changed the EnStation2 LAN IP address, enter the correct IP address.

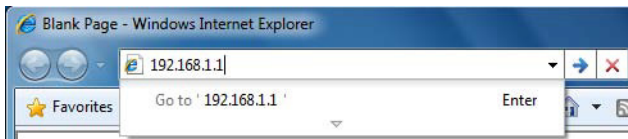

Figure 3-1: Web Browser Address Bar

3. When the login screen appears, enter `admin` for the username in the top field and `admin` for the password in the bottom field.

Figure 3-2: Windows Security Login Dialog

4. Click `Login` to continue or `Reset` to abort the login.

You are now ready to use the instructions in the following chapters to configure the EnStation2.

Best Practices

Perform the following procedures regularly to make the EnStation2 more secure and manage the EnStation2 more effectively.

- **Change the default password** Use a password that is not easy to guess and that contains different characters, such as numbers and letters. The EnStation2 username cannot be changed. For more information, see *Configuring Administrator Account*.
- **Back up the configuration** and be sure you know how to restore it. Restoring an earlier working configuration can be useful if the EnStation2 becomes unstable or crashes. If you forget your password, you will have to reset the EnStation2 to its factory default settings and lose any customized override settings you configured. However, if you back up an earlier configuration, you will not have to completely reconfigure the EnStation2. You can simply restore your last configuration. For more information, see *Configuring Backup/Restore Settings*.

Basic Network Settings

Chapter 4

4.1 System Status

View the summary of the current system status including system (hardware/software version, date/time), wired network (LAN) and wireless network (WLAN) information.

4.1.1 Using Save/Reload

Save and apply the settings shown in the Unsaved changes list, or cancel the unsaved changes and revert to the previous settings that were in effect.

Save/Reload

[Home](#)[Reset](#)

Unsaved changes list

```
network.sys.opmode=ap'  
wireless.wifi0.countryName=N/A
```

Caution: Network Setting changed, redirect IP to 192.168.1.1

[Save & Apply](#)[Revert](#)

4.1.2 Viewing System Information

Displays status information about the current operating mode.

System Information shows the general system information such as operating mode, system up time, firmware version, serial number, kernel version, and application version.

System Information

Device Name	ENSTATION2
Ethernet Main MAC Address	00:02:6F:EE:BB:BA
Ethernet Secondary MAC Address	00:02:6F:EE:BB:BA
Wireless MAC Address	00:02:6F:EE:BB:BA
Country	United States
Current Time	Tue Aug 5 18:56:33 UTC 2014
Firmware Version	1.5.8

LAN Settings shows Local Area Network settings such as the LAN IP address, subnet mask, and MAC address.

LAN Settings

IP Address	192.168.1.1
Subnet Mask	255.255.255.0
Default Gateway	192.168.1.1
Primary DNS	0.0.0.0
Secondary DNS	0.0.0.0
DHCP Client	Disabled
IPv6 IP Address	None
IPv6 Link-Local Address	FE80::202:6FFF:FEEE:BBBA
IPv6 Default Gateway	
IPv6 Primary DNS	
IPv6 Secondary DNS	
RX(Packets)	42.7949 KB (437 PKts.)
TX(Packets)	340.152 KB (396 PKts.)

WAN Settings shows Wide Area Network settings such as the MAC address, connection type, connection status, LAN IP address, subnet mask, primary and secondary DNS.

WAN Settings

MAC Address	00:02:6F:E4:61:C0
Connection Type	DHCP
Connection Status	Down
IP Address	
IP Subnet Mask	255.255.255.0
Primary DNS	
Secondary DNS	
RX(Packets)	0 B (0 PKts.)
TX(Packets)	10.3838 KB (217 PKts.)

Current Wireless Settings shows wireless information such as frequency and channel. Since the EnStation2 supports multiple-SSIDs, information about each SSID, such as its ESSID and security settings, are displayed.

Current Wireless Settings

Operation Mode	Client Router
Wireless Mode	IEEE 802.11b/g/n Mixed
Channel Bandwidth	20/40 MHz
Frequency/Channel	2.452 GHz (Channel 9)
Wireless Network Name (SSID)	AP SSID
Security	None
Distance	1 Km
RX(Packets)	0 B (0 PKts.)
TX(Packets)	10.3838 KB (217 PKts.)

4.1.3 Viewing Wireless Client List

Client List

[Home](#)[Reset](#)

SSID:#	MAC Address	TX(Bytes)	RX(Bytes)	RSSI(dBm)	Kick and Ban
--------	-------------	-----------	-----------	-----------	--------------

[Refresh](#)

Displays a list of clients associated to the EnStation2, along with the MAC addresses and signal strength for each client. To remove an SSID client from the list, click the button that appears in the Kick and Ban column.

Click the `Refresh` button to update the client list.

4.1.4 Viewing System Log

Home
Reset

System Log

Show log type All ▼

```

Feb  1 03:48:15 ENS202 user.warn kernel: ath_tx_edma_tasklet: TXQ[3] tailindex 1
Feb  1 03:48:04 ENS202 user.warn kernel: ath_tx_edma_tasklet: TXQ[3] tailindex 1
Feb  1 03:48:04 ENS202 user.warn kernel: ath_tx_edma_tasklet: TXQ[3] tailindex 1
Feb  1 03:47:51 ENS202 user.warn kernel: ath_tx_edma_tasklet: TXQ[3] tailindex 1
Feb  1 03:47:10 ENS202 user.warn kernel: ath_tx_edma_tasklet: TXQ[3] tailindex 1
Feb  1 03:46:18 ENS202 user.warn kernel: ath_tx_edma_tasklet: TXQ[3] tailindex 1
Feb  1 03:46:10 ENS202 user.warn kernel: ath_tx_edma_tasklet: TXQ[3] tailindex 1
Feb  1 03:46:04 ENS202 user.warn kernel: ath_tx_edma_tasklet: TXQ[3] tailindex 1
Feb  1 03:45:58 ENS202 user.warn kernel: ath_tx_edma_tasklet: TXQ[3] tailindex 1
Feb  1 03:45:53 ENS202 user.warn kernel: ath_tx_edma_tasklet: TXQ[3] tailindex 1
Feb  1 03:45:51 ENS202 user.warn kernel: ath_tx_edma_tasklet: TXQ[3] tailindex 1
Feb  1 03:45:41 ENS202 user.warn kernel: ath_tx_edma_tasklet: TXQ[3] tailindex 1
Feb  1 03:45:32 ENS202 user.warn kernel: ath_tx_edma_tasklet: TXQ[3] tailindex 1
Feb  1 03:45:25 ENS202 user.warn kernel: ath_tx_edma_tasklet: TXQ[3] tailindex 1
Feb  1 03:45:24 ENS202 user.warn kernel: ath_tx_edma_tasklet: TXQ[3] tailindex 1
Feb  1 03:45:12 ENS202 user.warn kernel: ath_tx_edma_tasklet: TXQ[3] tailindex 1
Feb  1 03:45:01 ENS202 user.notice root: starting ntpd
Feb  1 03:45:01 ENS202 cron.info crond[1603]: crond: USER root pid 3876 cmd . /etc/hotplug.d/iface/20-
Feb  1 03:44:51 ENS202 user.warn kernel: ath_tx_edma_tasklet: TXQ[3] tailindex 1
Feb  1 03:44:45 ENS202 user.warn kernel: ath_tx_edma_tasklet: TXQ[3] tailindex 1
Feb  1 03:44:37 ENS202 user.warn kernel: ath_tx_edma_tasklet: TXQ[3] tailindex 1
Feb  1 03:44:32 ENS202 user.warn kernel: ath_tx_edma_tasklet: TXQ[3] tailindex 1
          
```

Save
Refresh
Clear

The EnStation2 automatically logs events to internal memory.

Note:

The oldest events are deleted from the log when memory is full.

Click the `Refresh` button to update the client list or the `Clear` button to remove all events.

4.1.5 Viewing Connection Status

Displays the current status of the network.

The WLAN information shown includes network type, SSID, BSSID, connection status, wireless mode, current channel, security, data rate, noise level, and signal strength.

Wireless	
Network Type	Client Router
SSID	AP SSID
BSSID	N/A
Connection Status	N/A
Wireless Mode	N/A
Current Channel	N/A
Security	N/A
Tx Data Rates(Mbps)	N/A
Current noise level	N/A
Signal strength	N/A

The WAN information shown includes the MAC address, connection type, connection status, IP address, IP subnet mask, primary DNS and secondary DNS.

WAN	
MAC Address	00:02:6F:E4:61:C0
Connection Type	DHCP <input type="button" value="Renew"/> <input type="button" value="Release"/>
Connection Status	Down
IP Address	
IP Subnet Mask	255.255.255.0
Primary DNS	
Secondary DNS	

Click the `Refresh` button to update the client list or the `Clear` button to remove all events.

4.1.6 Viewing DHCP Client Table

DHCP Client List

[Home](#)[Reset](#)

MAC addr	IP	Host Name	Expires	Revoke	Reserve
----------	----	-----------	---------	--------	---------

[Refresh](#)

Displays the clients that are associated to the EnStation2 through DHCP. The MAC addresses and signal strength for each client are also shown.

Click the `Refresh` button to update the client list.

4.1.7 Viewing WDS Link List

WDS Link Status

[Home](#)[Reset](#)

WDS Link ID	MAC Address	Link Status	RSSI (dBm)
-------------	-------------	-------------	------------

[Refresh](#)

Displays the clients that are associated to the EnStation2 through WDS. The MAC addresses, link status and signal strength for each client are also shown.

Click the `Refresh` button to update the client list.

4.2 System Setup

The following sections explain the features and functionality of the EnStation2 in access point mode, client bridge mode, WDS access point mode, WDS bridge mode, WDS station mode and client router mode.

4.2.1 Configuring Operation Mode

Set the primary function of the device. The function that is selected affects which items are available in the main menu.

Device Name Enter a name for the device. The name you type appears in SNMP management. This name is not the SSID and is not broadcast to other devices.

Operation Mode Use the radio button to select an operating mode.

Click **Save & Apply** to save changes or **Cancel** to abort.

System Properties		Home	Reset
System Properties			
Device Name	ENSTATION2 (1 to 32 characters)	Green	
Country/Region	United States		
Operation Mode	<input type="radio"/> Access Point <input checked="" type="radio"/> Client Bridge <input type="radio"/> WDS <input type="radio"/> Client Router		
Save & Apply		Cancel	

4.2.2 Configuring IP Settings

Configure the EnStation2 LAN settings for the EnStation2 using a static or dynamic IP address.

IP Network Setting Configure the network connection type using either a static IP or dynamic IP.

IP Address Enter the LAN IP address of the EnStation2.

Subnet Mask Enter the subnet mask of the EnStation2.

Default Gateway Enter the default gateway of the EnStation2.

Primary DNS Enter the primary DNS address of the EnStation2.

Secondary DNS Enter the secondary DNS address of the EnStation2.

Use Link-Local Address Click to enable a link-local address for the device.

IPv6 IP Address Enter the IPv6 LAN IP address of the EnStation2.

IPv6 Subnet Prefix Length Enter the IPv6 subnet prefix length of the EnStation2.

IPv6 Default Gateway Enter the IPv6 default gateway of the EnStation2.

IPv6 Primary DNS Enter the IPv6 primary DNS of the EnStation2.

IPv6 Secondary DNS Enter the IPv6 secondary DNS of the EnStation2.

Click **Apply** to save the settings or **Cancel** to discard changes.

IP Settings

System Information	
IP Network Setting	<input type="radio"/> Obtain an IP address automatically (DHCP) <input checked="" type="radio"/> Specify an IP address
IP Address	192 . 168 . 1 . 220
IP Subnet Mask	255 . 255 . 255 . 0
Default Gateway	192 . 168 . 1 . 1
Primary DNS	0 . 0 . 0 . 0
Secondary DNS	0 . 0 . 0 . 0
Use Link-Local Address	<input checked="" type="checkbox"/>
IPv6 IP Address	<input type="text"/>
IPv6 Subnet Prefix Length	<input type="text"/>
IPv6 Default Gateway	<input type="text"/>
IPv6 Primary DNS	<input type="text"/>
IPv6 Secondary DNS	<input type="text"/>

4.2.3 Configuring Spanning Tree Settings

Spanning Tree Status Enable or disable the EnStation2 Spanning Tree function.

Bridge Hello Time Specify Bridge Hello Time, in seconds. This value determines how often the EnStation2 sends hello packets to communicate information about the topology throughout the entire Bridged Local Area Network

Bridge Max Age Specify Bridge Max Age, in seconds. If another bridge in the spanning tree does not send a hello packet for a long period of time, it is assumed to be dead.

Bridge Forward Delay Specify Bridge Forward Delay, in seconds. Forwarding delay time is the time spent in each of the Listening and Learning states before the Forwarding state is entered. This delay is provided so that when a new bridge comes onto a busy network, it looks at some traffic before participating.

Priority Specify the Priority number. Smaller numbers have greater priority.

Click `Accept` to confirm the changes or `Cancel` to cancel and return previous settings.

Spanning Tree Settings

Spanning Tree Status	<input type="radio"/> On <input checked="" type="radio"/> Off
Bridge Hello Time	2 seconds (1-10)
Bridge Max Age	20 seconds (6-40)
Bridge Forward Delay	4 seconds (4-30)
Priority	32768 (0-65535)

Accept

Cancel

4.3 Router Setup

4.3.1 Configuring WAN Settings

Configure the WAN settings for the EnStation2 using a static or dynamic IP address, PPPoE or PPTP.

Static IP

Setting a static IP address allows an administrator to set a specific IP address for the router and guarantees that it can not be assigned a different address.

Account Name Enter the account name provided by your ISP.

Domain Name Enter the domain name provided by your ISP.

MTU The maximum transmission unit (MTU) specifies the largest packet size permitted for an internet transmission. The factory default MTU size for static IP is 1500. The MTU size can be set between 576 and 1500.

IP Address Enter the router's WAN IP address.

Subnet Mask Enter the router's WAN subnet mask.

Default Gateway Enter the WAN gateway address.

Primary DNS Enter the primary DNS server address.

WAN Settings

Internet Connection Type	Static IP			
Options				
Account Name (if required)	<input type="text"/>			
Domain Name (if required)	<input type="text"/>			
MTU	Auto	1500	(576 - 1500)	
Internet IP Address				
IP Address	192	168	10	1
IP Subnet Mask	255	255	255	0
Gateway IP Address	0	0	0	0
Domain Name Server (DNS) Address				
Primary DNS	0	0	0	0
Secondary DNS	0	0	0	0
WAN Ping				
Discard Ping on WAN	<input checked="" type="checkbox"/>			

Secondary DNS Enter the secondary DNS server address.

Discard Ping on WAN Check to Enable to recognize pings on the EnStation2 WAN interface or Disable to block pings on the EnStation2 WAN interface. Note: Pinging IP addresses is a common method used by hackers to test whether the IP address is valid. Blocking pings provides some extra security from hackers.

Click **Accept** to save the settings or **Cancel** to discard changes.

Dynamic IP

Dynamic IP addressing assigns a different IP address each time a device connects to an ISP service provider. The service is most commonly used by ISP cable providers.

Account Name Enter the account name provided by your ISP.

Domain Name Enter the domain name provided by your ISP.

MTU The maximum transmission unit (MTU) specifies the largest packet size permitted for an internet transmission. The factory default MTU size for Dynamic IP is 1500. The MTU size can be set between 576 and 1500.

Get Automatically From ISP Click the radio button to obtain the DNS automatically from the DHCP server.

Use These DNS Servers Click the radio button to set up the Primary DNS and Secondary DNS servers manually.

Discard Ping on WAN Check to Enable to recognize pings on the EnStation2 WAN interface or Disable to block pings on the EnStation2 WAN interface. Note: Pinging IP addresses is a common method used by hackers to test whether the IP address is valid. Blocking pings provides some extra security from hackers.

Click **Accept** to save the settings or **Cancel** to discard changes.

WAN Settings Home Reset

Internet Connection Type: DHCP

Options

Account Name (if required):

Domain Name (if required):

MTU: Auto 1500 (576 - 1500)

Domain Name Server (DNS) Address

Get Automatically From ISP

Use These DNS Servers

Primary DNS: 0 . 0 . 0 . 0

Secondary DNS: 0 . 0 . 0 . 0

WAN Ping

Discard Ping on WAN:

Accept Cancel

Point-to-Point Protocol over Ethernet (PPPoE)

Point-to-Point Protocol over Ethernet (PPPoE) is used mainly by ISPs that provide DSL modems to connect to the Internet.

MTU Enter the maximum transmission unit (MTU). The MTU specifies the largest packet size permitted for an internet transmission (PPPoE default: 1492). The MTU size can be set between 576 and 1492.

Login Enter the username assigned by an ISP.

Password Enter the password assigned by an ISP.

Service Name Enter the service name of an ISP (optional).

Connect on Demand Select the radio button to specify the maximum idle time. Internet connection will disconnect when it reach the maximum idle time, but it will automatically connect when user tries to access the network.

Keep Alive Select whether to keep the Internet connection always on, or enter a redial period once the internet lose connection.

Get Automatically From ISP Click the radio button to obtain the DNS automatically from the ISP.

Use These DNS Servers Click the radio button to set up the Primary DNS and Secondary DNS servers manually.

Discard Ping on WAN Check to Enable to recognize pings on the EnStation2 WAN interface or Disable to block pings on the EnStation2 WAN interface. Note: Pinging IP addresses is a common method used by hackers to test whether the IP address is valid. Blocking pings provides some extra security from hackers.

Click `Accept` to save the settings or `Cancel` to discard changes.

WAN Settings

Internet Connection Type: PPPoE

Options

MTU: Auto 1492 (576 - 1492)

PPPoE Options

Login:

Password:

Service Name (if required):

Connect on Demand: Max idle Time Minutes
 Keep Alive: Redial Period Seconds

Domain Name Server (DNS) Address

Get Automatically From ISP
 Use These DNS Servers

Primary DNS: . . .

Secondary DNS: . . .

WAN Ping

Discard Ping on WAN:

Point-to-Point Tunnelling Protocol (PPTP)

The point-to-point tunnelling protocol (PPTP) is used in association with virtual private networks (VPNs). There are two parts to a PPTP connection: the WAN interface settings and the PPTP settings.

MTU Enter the maximum transmission unit (MTU). The MTU specifies the largest packet size permitted for an internet transmission (PPPoE default: 1400). The MTU size can be set between 1200 and 1400.

IP Address Enter the router's WAN IP address.

Subnet Mask Enter the router's WAN subnet IP address.

Default Gateway Enter the router's WAN gateway IP address.

PPTP Server Enter the IP address of the PPTP server.

Username Enter the username provided by your ISP.

Password Enter the password provided by your ISP.

Connect on Demand If you want the EnStation2 to end the Internet connection after it has been inactive for a period of time, select this option and enter the number of minutes you want that period of inactivity to last.

Keep Alive If you want the EnStation2 to periodically check your Internet connection, select this option. Then specify how often you want the EnStation2 to check the Internet connection. If the connection is down, the EnStation2 automatically re-establishes your connection.

Get Automatically From ISP Obtains the DNS automatically from ISP.

WAN Settings

Internet Connection Type: PPTP

Options

MTU: Auto (1400) (1200 - 1400)

PPTP Options

IP Address: 192 . 168 . 10 . 1

Subnet Mask: 255 . 255 . 255 . 0

Default Gateway: 0 . 0 . 0 . 0

PPTP Server: 0 . 0 . 0 . 0

Username:

Password:

Connect on Demand: Max idle Time 15 Minutes
 Keep Alive: Redial Period 30 Seconds

Domain Name Server (DNS) Address

Get Automatically From ISP
 Use These DNS Servers

Primary DNS: 0 . 0 . 0 . 0

Secondary DNS: 0 . 0 . 0 . 0

WAN Ping

Discard Ping on WAN:

Use These DNS Servers Click the radio button to set up the Primary DNS and Secondary DNS servers manually.

Discard Ping on WAN Check to Enable to recognize pings on the EnStation2 WAN interface or Disable to block pings on the EnStation2 WAN interface. Note: Pinging IP addresses is a common method used by hackers to test whether the IP address is valid. Blocking pings provides some extra security from hackers.

Click `Accept` to save the settings or `Cancel` to discard changes.

4.3.2 Configuring LAN Settings

IP Address Enter the LAN port IP address.

IP Subnet Mask Enter the LAN IP subnet mask.

WINS Server IP Enter the WINS Server IP.

Use Router As DHCP Server Check this option to enable the EnStation2 internal DHCP server.

Starting IP Address Specify the starting IP address range for the pool of allocated for private IP addresses. The starting IP address must be on the same subnet as the ending IP address; that is the first three octets specified here must be the same as the first three octets in End IP Address.

Ending IP Address Specify the ending IP address range for the pool of allocated for private IP addresses. The ending IP address must be on the same subnet as the starting IP address; that is the first three octets specified here must be the same as the first three octets in Start IP Address.

WINS Server IP Enter the IP address of the WINS server.

Click `Accept` to confirm the changes or `Cancel` to cancel and return previous settings.

LAN Settings

LAN IP Setup

IP Address	192	.	168	.	1	.	153
IP Subnet Mask	255	.	255	.	255	.	0

Use Router As DHCP Server

Starting IP Address	192	.	168	.	1	.	100
Ending IP Address	192	.	168	.	1	.	200
WINS Server IP	0	.	0	.	0	.	0

Accept

Cancel

4.3.3 Configuring VPN Pass-Through

VPN Pass-through allows a secure virtual private network (VPN) connection between two computers. Enabling the options on this page opens a VPN port and enables connections to pass through the EnStation2 without interruption.

PPTP Pass-through Check this option to enable PPTP pass-through mode.

L2TP Pass-through Check this option to enable L2TP pass-through mode.

IPSec Pass-through Check this option to enable IPSec pass-through mode.

Click `Accept` to confirm the changes or `Cancel` to cancel and return previous settings.

VPN Pass Through

PPTP Pass Through

L2TP Pass Through

IPSec Pass Through

Accept

Cancel

4.3.4 Configuring Port Forwarding

Port forwarding enables multiple server applications on a LAN to serve clients on a WAN over a single WAN IP address. The router accepts incoming client packets, filters them based on the destination WAN, or public, port and protocol and forwards the packets to the appropriate LAN, or local, port. Unlike the DMZ feature, port forwarding protects LAN devices behind the firewall.

Port Forwarding

[Home](#)
[Reset](#)

#	Name	Protocol	Start Port	End Port	Server IP Address	Enable	Modify	Delete
---	------	----------	------------	----------	-------------------	--------	--------	--------

[Add Entry](#)
[Accept](#)

NO. Displays the sequence number of the forwarded port.

Name Displays the name of the forwarded port.

Protocol Displays the protocol to use for mapping from the following: TCP, UDP or Both.

Start Port Displays the LAN port number that WAN client packets will be forward to.

End Port Displays the port number that the WAN client packets are received.

Server IP Displays the IP address of the server for the forwarded port.

Enable Click to enable or disable the forwarded port profile.

Modify Click to modify the forwarded port profile.

Delete Click to delete the forwarded port profile.

Click [Add Entry](#) to add port forwarding rules.

Click [Accept](#) to confirm the changes.

Service Name Enter a name for the port forwarding rule.

Protocol Select a protocol for the application: Choices are Both, TCP, and UDP.

Starting Port Enter a starting port number.

Ending Port Enter an ending port number. All ports numbers between the starting and ending ports will forward users to the IP address specified in the IP Address field.

IP Address Enter the IP address of the server computer on the LAN network where users will be redirected.

Click `Save` to apply the changes or `Cancel` to return previous settings.

Port Forwarding

Service Name	<input type="text"/>
Protocol	BOTH <input type="button" value="v"/>
Starting Port	<input type="text"/> (1~65535)
Ending Port	<input type="text"/> (1~65535)
IP Address	<input type="text"/> . <input type="text"/> . <input type="text"/> . <input type="text"/>

4.3.5 Configuring Demilitarized Zone

Configuring a device on the LAN as a demilitarized zone (DMZ) host allows unrestricted two-way Internet access for Internet applications, such as online video games, to run from behind the NAT firewall. The DMZ function allows the router to redirect all packets going to the WAN port IP address to a particular IP address on the LAN. The difference between the virtual server and the DMZ function is that a virtual server redirects a particular service or Internet application, such as FTP, to a particular LAN client or server, whereas a DMZ redirects all packets, regardless of the service, going to the WAN IP address to a particular LAN client or server.



WARNING!

The PC defined as a DMZ host is not protected by the firewall and is vulnerable to malicious network attacks. Do not store or manage sensitive information on the DMZ host.

DMZ Hosting Select `Enable` DMZ to activate DMZ functionality.

DMZ Address Enter an IP address of a device on the LAN.

Click `Accept` to confirm the changes or `Cancel` to cancel and return previous settings.

DMZ

DMZ Hosting	Disable ▾
DMZ Address	0 . 0 . 0 . 0

`Accept` `Cancel`

4.4 Configuring Wireless LAN

4.4.1 Configuring Wireless Settings

Instructions on how to configure the wireless and security settings for each of the possible operating modes.



WARNING!

Incorrectly changing these settings may cause the device to stop functioning. Do not modify the settings in this section without a thorough understanding of the parameters.

Access Point Mode

The EnStation2 supports Access Point Mode. In this mode, users with a wireless client device within range can connect to the EnStation2 to access the WLAN.

Wireless Mode Wireless mode supports 802.11b/g/n mixed modes.

Channel HT Mode The default channel bandwidth is 20/40 MHz. The larger the channel, the better the transmission quality and speed.

Extension Channel Select upper or lower channel. Your selection may affect the Auto channel function.

Channel / Frequency Select the channel and frequency appropriate.

Auto Check this option to enable auto-channel selection.

Home Reset

Wireless Network					
Wireless Mode	802.11 B/G/N Mixed				
Channel HT Mode	20/40MHz				
Extension Channel	Lower Channel				
Channel / Frequency	Ch5-2.432GHz <input checked="" type="checkbox"/> Auto				
AP Detection	<input type="button" value="Scan"/>				
Current Profiles					
SSID	Security	Isolation	VID	Enable	Edit
EnGeniusE461C0	None	<input type="checkbox"/>	1	<input checked="" type="checkbox"/>	<input type="button" value="Edit"/>
EnGeniusE461C0_2	None	<input type="checkbox"/>	2	<input type="checkbox"/>	<input type="button" value="Edit"/>
EnGeniusE461C0_3	None	<input type="checkbox"/>	3	<input type="checkbox"/>	<input type="button" value="Edit"/>
EnGeniusE461C0_4	None	<input type="checkbox"/>	4	<input type="checkbox"/>	<input type="button" value="Edit"/>

Accept Cancel

AP Detection AP Detection can select the best channel to use by scanning nearby areas for Access Points.

Current Profile Configure up to four different SSIDs. If many client devices will be accessing the network, you can arrange the devices into SSID groups. Click `Edit` to configure the profile and check whether you want to enable extra SSIDs.

Click `Accept` to confirm the changes or `Cancel` to cancel and return previous settings.

SSID Specify the SSID for the current profile.

VLAN ID Specify the VLAN tag for the current profile.

Suppressed SSID Check this option to hide the SSID from clients. If checked, the SSID will not appear in the site survey.

Station Separation Click the appropriate radio button to allow or prevent communication between client devices.

Wireless Security See the Wireless Security section.

Click `Save` to accept the changes or `Cancel` to cancel and return previous settings.

SSID Profile

Wireless Setting

SSID	EnGeniusE461C0	(1 to 32 characters)
VLAN ID	1	(1~4094)
Suppressed SSID	<input type="checkbox"/>	
Station Separation	<input type="radio"/> Enable <input checked="" type="radio"/> Disable	

Wireless Security

Security Mode	Disabled
---------------	----------

Client Bridge Mode

Client Bridge Mode lets you connect two LAN segments via a wireless link as though they are on the same physical network. Since the computers are on the same subnet, broadcasts reach all machines. As a result, DHCP information generated by the server reach all client computers as though the clients residing on one physical network.

Wireless Mode Wireless mode supports 802.11b/g/n mixed modes.

SSID Specify the SSID if known. This field is completed automatically if you select an Access Point in the Site Survey.

Site Survey Scans nearby locations for Access Points. You can select a discovered Access Point to establish a connection.

Prefer BSSID Enter the MAC address if known. If you select an Access Point in the Site Survey, this field is completed automatically.

Wireless Security For details on wireless security settings, see *Configuring Wireless Security*.

Click **Accept** to confirm the changes or **Cancel** to cancel and return previous settings.

Wireless Network

Wireless Mode	802.11 B/G/N Mixed
SSID	Specify the static SSID : AP SSID (1 to 32 characters) Or press the button to search for any available WLAN Service. <input type="button" value="Site Survey"/>
Prefered BSSID	<input type="checkbox"/> : : : : :
Wireless Security	
Changing the wireless security settings may cause this wireless client to associate with a different one. This may temporarily disrupt your configuration session.	
Security Mode	Disabled

Profile If you used the Site Survey, the Web Configurator shows nearby Access Points. To connect to an Access Point, click the Access Point's BSSID.

Wireless Security See *Configuring Wireless Security*.

Click **Refresh** to scan again.

Site Survey

2GHz Site Survey

Infrastructure Ad_hoc

BSSID	SSID	Channel	Signal Level	Type	Security	Mode
08:10:74:96:17:04	DT-200N	6	-93 dBm	11g/n	none	
00:16:01:93:C8:6F	00160193C86E	11	-81 dBm	11b/g	WEP	
04:4F:AA:5B:88:C1	annie	1	-93 dBm	11b/g	WEP	
02:2F:4F:42:BC:41	HPCP1525-9b886b	6	-91 dBm	11b/g	none	
90:E6:BA:BE:8A:46	james wifi	1	-84 dBm	11b/g	WPA/WPA2-PSK	
F0:B4:79:06:0C:8D	AE	1	-96 dBm	11g/n	WPA2-PSK	
00:19:70:22:05:96	NOVA Technical Institute	7	-55 dBm	11g/n	WPA2-PSK	
4C:E6:76:43:1E:6B	mike	11	-79 dBm	11g/n	WPA-PSK	
00:1F:1F:23:F9:F0	kao	11	-86 dBm	11g/n	WPA-PSK	
34:08:04:DD:81:02	RouterforTecom	11	-83 dBm	11b/g	WPA/WPA2-PSK	
5C:D9:98:E1:56:94	TW FlyKiwi	6	-94 dBm	11g/n	WPA/WPA2-PSK	

Refresh

WDS Bridge Mode

Unlike traditional bridging, WDS Bridge Mode allows you to create large wireless networks by linking several wireless access points with WDS links. WDS is normally used in large, open areas, where pulling wires is cost prohibitive, restricted or physically impossible.

Wireless Mode Wireless mode supports 802.11b/g/n mixed modes.

Channel HT Mode The default channel bandwidth is 40 MHz. The larger the channel, the better the transmission quality and speed.

Extension Channel Select upper or lower channel. Your selection may affect the Auto channel function.

Channel / Frequency Select the channel and frequency appropriate.

Click `Accept` to confirm the changes or `Cancel` to cancel and return previous settings.

Wireless Network

Wireless Mode	802.11 B/G/N Mixed ▾
Channel HT Mode	40MHz ▾
Extension Channel	Lower Channel ▾
Channel / Frequency	Ch6-2.437GHz ▾

Security Select the type of WDS security: None, WEP, or AES.

WEP Key Enter the WEP key.

AES Pass phrase Enter the AES pass phrase.

MAC Address Enter the MAC address of the Access Point to which you want to extend wireless connectivity.

Mode Select Disable or Enable to disable or enable WDS.

Click **Accept** to confirm the changes or **Cancel** to cancel and return previous settings.

WDS Link Settings

[Home](#) [Reset](#)

Security	None
WEP Key	<input type="text"/> 40/64-bit(10 hex digits)
AES Passphrase	<input type="text"/> <small>(8-63 ASCII characters or 64 hexadecimal digits)</small>

ID	MAC Address	Mode
1	<input type="text"/> : <input type="text"/> : <input type="text"/> : <input type="text"/> : <input type="text"/> : <input type="text"/>	Disable
2	<input type="text"/> : <input type="text"/> : <input type="text"/> : <input type="text"/> : <input type="text"/> : <input type="text"/>	Disable
3	<input type="text"/> : <input type="text"/> : <input type="text"/> : <input type="text"/> : <input type="text"/> : <input type="text"/>	Disable
4	<input type="text"/> : <input type="text"/> : <input type="text"/> : <input type="text"/> : <input type="text"/> : <input type="text"/>	Disable

[Accept](#) [Cancel](#)

Client Router Mode

In Client Router Mode, you can access the Internet wirelessly with the support of a WISP. In AP Router Mode, the EnStation2 can access the Internet via a cable or DSL modem. In this mode, the EnStation2 can be configured to turn off the wireless network name (SSID) broadcast, so that only stations that have the SSID can be connected. The EnStation2 also provides wireless LAN 64/128/156-bit WEP encryption security, WPA/WPA2, and WPA-PSK/WPA2-PSK authentication, as well as TKIP/AES encryption security. It also supports VPN pass-through for sensitive data secure transmission.

Wireless Mode Wireless mode supports 802.11b/g/n mixed modes.

SSID Specify the SSID if known. This field is completed automatically if you select an Access Point in the Site Survey.

Site Survey Scans nearby locations for Access Points. You can select a discovered Access Point to establish a connection.

Prefer BSSID Enter the MAC address if known. If you select an Access Point in the Site Survey, this field is completed automatically.

Wireless Security See *Configuring Wireless Security*.

Click `Accept` to confirm the changes or `Cancel` to cancel and return previous settings.

Wireless Network

Wireless Mode	802.11 B/G/N Mixed
SSID	Specify the static SSID : AP SSID <input type="text"/> (1 to 32 characters) Or press the button to search for any available WLAN Service. <input type="button" value="Site Survey"/>
Prefered BSSID	<input type="checkbox"/> <input type="text"/> : <input type="text"/> : <input type="text"/> : <input type="text"/> : <input type="text"/> : <input type="text"/>

Wireless Security

Changing the wireless security settings may cause this wireless client to associate with a different one. This may temporarily disrupt your configuration session.

Security Mode	Disabled
---------------	----------

Profile If you used the Site Survey, the Web Configurator shows nearby Access Points. To connect to an Access Point, click the Access Point's BSSID.

Wireless Security See *Configuring Wireless Security*.

Click **Refresh** to scan again.

Site Survey

2GHz Site Survey

Infrastructure Ad_hoc

BSSID	SSID	Channel	Signal Level	Type	Security	Mode
08:10:74:96:17:04	DT-200N	6	-93 dBm	11g/n	none	
00:16:01:93:C8:6F	00160193C86E	11	-81 dBm	11b/g	WEP	
04:4F:AA:5B:88:C1	annie	1	-93 dBm	11b/g	WEP	
02:2F:4F:42:BC:41	HPCP1525-9b886b	6	-91 dBm	11b/g	none	
90:E6:BA:BE:8A:46	james wifi	1	-84 dBm	11b/g	WPA/WPA2-PSK	
F0:B4:79:06:0C:8D	AE	1	-96 dBm	11g/n	WPA2-PSK	
00:19:70:22:05:96	NOVA Technical Institute	7	-55 dBm	11g/n	WPA2-PSK	
4C:E6:76:43:1E:6B	mike	11	-79 dBm	11g/n	WPA-PSK	
00:1F:1F:23:F9:F0	kao	11	-86 dBm	11g/n	WPA-PSK	
34:08:04:DD:81:02	RouterforTecom	11	-83 dBm	11b/g	WPA/WPA2-PSK	
5C:D9:98:E1:56:94	TW FlyKiwi	6	-94 dBm	11g/n	WPA/WPA2-PSK	

Refresh

4.4.2 Configuring Wireless Security

The Wireless Security Settings section lets you configure the EnStation2's security modes: WEP, WPA-PSK, WPA2-PSK, WPA-PSK Mixed, WPA, WPA2, and WPA Mixed. We strongly recommend you use WPA2-PSK.

Wired Equivalent Privacy (WEP)

Security Mode Select WEP from the drop-down list to begin the configuration.

Auth Type Select Open System or Shared.

Input Type Select an input type of Hex or ASCII.

Key Length Level of WEP encryption applied to all WEP keys. Select a 64/128/152-bit password lengths.

Default Key Specify which of the four WEP keys the EnStation2 uses as its default.

Key1 - Key4 Specify a password for the security key index. For security, each typed character is masked by a dot.

Click *Save* to save the changes or *Cancel* to cancel and return previous settings.

Wireless Security	
Security Mode	WEP
Auth Type	Open System
Input Type	Hex
Key Length	40/64-bit (10 hex digits or 5 ASCII char)
Default Key	1
Key1	
Key2	
Key3	
Key4	

Save Cancel



Note:

802.11n does not allow WEP/WPA-PSK TKIP/WPA2-PSK TKIP security mode. The connection mode will change from 802.11n to 802.11g.

Wi-Fi Protected Access Pre-Shared Key (WPA-PSK)

Security Mode Select WPA-PSK from the drop-down list to begin the configuration.

Encryption Select Both, TKIP, or AES as the encryption type.

- Both = uses TKIP and AES.
- TKIP = automatic encryption with WPA-PSK; requires passphrase.
- AES = automatic encryption with WPA2-PSK; requires passphrase.

Passphrase Specify the security password. For security, each typed character is masked by a dot.

Group Key Update Interval Specify how often, in seconds, the group key changes.

Click **Save** to save the changes or **Cancel** to cancel and return previous settings.

Wireless Security	
Security Mode	WPA-PSK
Encryption	Both(TKIP+AES)
Passphrase	<input type="text"/> (8 to 63 characters) or (64 Hexadecimal characters)
Group Key Update Interval	3600 seconds(30~3600, 0: disabled)



Note:

802.11n does not allow WEP/WPA-PSK TKIP/WPA2-PSK TKIP security mode. The connection mode will change from 802.11n to 802.11g.

Wi-Fi Protected Access 2 Pre-Shared Key (WPA2-PSK)

Security Mode Select WPA2-PSK from the drop-down list to begin the configuration.

Encryption Select Both, TKIP, or AES as the encryption type.

- Both = uses TKIP and AES.
- TKIP = automatic encryption with WPA-PSK; requires passphrase.
- AES = automatic encryption with WPA2-PSK; requires passphrase.

Passphrase Specify the security password. For security, each typed character is masked by a dot.

Group Key Update Interval Specify how often, in seconds, the group key changes.

Click **Save** to save the changes or **Cancel** to cancel and return previous settings.

Wireless Security	
Security Mode	WPA2-PSK <input type="button" value="v"/>
Encryption	Both(TKIP+AES) <input type="button" value="v"/>
Passphrase	<input type="text"/> (8 to 63 characters) or (64 Hexadecimal characters)
Group Key Update Interval	3600 <input type="text"/> seconds(30~3600, 0: disabled)



Note:

802.11n does not allow WEP/WPA-PSK TKIP/WPA2-PSK TKIP security mode. The connection mode will change from 802.11n to 802.11g.

Wi-Fi Protected Access Pre-Shared Key (WPA-PSK) Mixed

Security Mode Select WPA2-PSK Mixed from the drop-down list to begin the configuration.

Encryption Select Both, TKIP, or AES as the encryption type.

- Both = uses TKIP and AES.
- TKIP = automatic encryption with WPA-PSK; requires passphrase.
- AES = automatic encryption with WPA2-PSK; requires passphrase.

Passphrase Specify the security password. For security, each typed character is masked by a dot.

Group Key Update Interval Specify how often, in seconds, the group key changes.

Click *Save* to save the changes or *Cancel* to cancel and return previous settings.

Wireless Security	
Security Mode	WPA-PSK Mixed ▾
Encryption	Both(TKIP+AES) ▾
Passphrase	<input type="text"/> (8 to 63 characters) or (64 Hexadecimal characters)
Group Key Update Interval	3600 <input type="text"/> seconds(30~3600, 0: disabled)



Note:

WPA-PSK Mixed can allow multiple security modes at the same time. 802.11n does not allow WEP/WPA-PSK TKIP/WPA2-PSK TKIP security mode. The connection mode will change from 802.11n to 802.11g.

Wi-Fi Protected Access (WPA)

Security Mode Select WPA from the drop-down list to begin the configuration.

Encryption Select Both, TKIP, or AES as the encryption type.

- Both = uses TKIP and AES.
- TKIP = automatic encryption with WPA-PSK; requires passphrase.
- AES = automatic encryption with WPA2-PSK; requires passphrase.

Radius Server Specify the IP address of the RADIUS server.

Radius Port Specify the port number that your RADIUS server uses for authentication. Default port is 1812.

Radius Secret Specify RADIUS secret furnished by the RADIUS server.

Group Key Update Interval Specify how often, in seconds, the group key changes.

Radius Accounting Select to enable or disable RADIUS accounting.

Radius Accounting Server Specify the IP address of the RADIUS accounting server.

Radius Accounting Port Specify the port number that your RADIUS accounting server uses for authentication. Default port is 1813.

Radius Accounting Secret Specify RADIUS accounting secret furnished by the RADIUS server.

Interem Accounting Interval Specify the interem accounting interval (60 - 600 seconds).

Click **Save** to save the changes or **Cancel** to cancel and return previous settings.



Note:

802.11n does not allow WEP/WPA-PSK TKIP/WPA2-PSK TKIP security mode. The connection mode will change from 802.11n to 802.11g.

Wireless Security

Security Mode	WPA
Encryption	Both(TKIP+AES)
Radius Server	<input type="text" value="."/> . <input type="text" value="."/> . <input type="text" value="."/> . <input type="text" value="."/>
Radius Port	1812
Radius Secret	<input type="text"/>
Group Key Update Interval	3600 <input type="text"/> seconds(30~3600, 0: disabled)
Radius Accounting	Enable
Radius Accounting Server	<input type="text" value="."/> . <input type="text" value="."/> . <input type="text" value="."/> . <input type="text" value="."/>
Radius Accounting Port	1813
Radius Accounting Secret	<input type="text"/>
Interim Accounting Interval	600 <input type="text"/> seconds(60~600)

Wi-Fi Protected Access 2 (WPA2)

Security Mode Select WPA2 from the drop-down list to begin the configuration.

Encryption Select Both, TKIP, or AES as the encryption type.

- Both = uses TKIP and AES.
- TKIP = automatic encryption with WPA-PSK; requires passphrase.
- AES = automatic encryption with WPA2-PSK; requires passphrase.

Radius Server Specify the IP address of the RADIUS server.

Radius Port Specify the port number that your RADIUS server uses for authentication. Default port is 1812.

Radius Secret Specify RADIUS secret furnished by the RADIUS server.

Group Key Update Interval Specify how often, in seconds, the group key changes.

Radius Accounting Select to enable or disable RADIUS accounting.

Radius Accounting Server Specify the IP address of the RADIUS accounting server.

Radius Accounting Port Specify the port number that your RADIUS accounting server uses for authentication. Default port is 1813.

Radius Accounting Secret Specify RADIUS accounting secret furnished by the RADIUS server.

Interem Accounting Interval Specify the interem accounting interval (60 - 600 seconds).

Click **Save** to save the changes or **Cancel** to cancel and return previous settings.



Note:

802.11n does not allow WEP/WPA-PSK TKIP/WPA2-PSK TKIP security mode. The connection mode will change from 802.11n to 802.11g.

Wireless Security	
Security Mode	WPA2
Encryption	Both(TKIP+AES)
Radius Server	<input type="text"/>
Radius Port	1812
Radius Secret	<input type="text"/>
Group Key Update Interval	3600 seconds(30~3600, 0: disabled)
Radius Accounting	Enable
Radius Accounting Server	<input type="text"/>
Radius Accounting Port	1813
Radius Accounting Secret	<input type="text"/>
Interim Accounting Interval	600 seconds(60~600)

Save Cancel

Wi-Fi Protected Access (WPA) Mixed

Security Mode Select WPA Mixed from the drop-down list to begin the configuration.

Encryption Select Both, TKIP, or AES as the encryption type.

- Both = uses TKIP and AES.
- TKIP = automatic encryption with WPA-PSK; requires passphrase.
- AES = automatic encryption with WPA2-PSK; requires passphrase.

Radius Server Specify the IP address of the RADIUS server.

Radius Port Specify the port number that your RADIUS server uses for authentication. Default port is 1812.

Radius Secret Specify RADIUS secret furnished by the RADIUS server.

Group Key Update Interval Specify how often, in seconds, the group key changes.

Radius Accounting Select to enable or disable RADIUS accounting.

Radius Accounting Server Specify the IP address of the RADIUS accounting server.

Radius Accounting Port Specify the port number that your RADIUS accounting server uses for authentication. Default port is 1813.

Radius Accounting Secret Specify RADIUS accounting secret furnished by the RADIUS server.

Interem Accounting Interval Specify the interem accounting interval (60 - 600 seconds).

Click **Save** to save the changes or **Cancel** to cancel and return previous settings.

Wireless Security	
Security Mode	WPA Mixed
Encryption	Both(TKIP+AES)
Radius Server	<input type="text" value="."/> . <input type="text" value="."/> . <input type="text" value="."/> . <input type="text" value="."/>
Radius Port	1812
Radius Secret	<input type="text"/>
Group Key Update Interval	3600 seconds(30~3600, 0: disabled)
Radius Accounting	Enable
Radius Accounting Server	<input type="text" value="."/> . <input type="text" value="."/> . <input type="text" value="."/> . <input type="text" value="."/>
Radius Accounting Port	1813
Radius Accounting Secret	<input type="text"/>
Interim Accounting Interval	600 seconds(60~600)

Save Cancel



Note:

802.11n does not allow WEP/WPA-PSK TKIP/WPA2-PSK TKIP security mode. The connection mode will change from 802.11n to 802.11g.

4.4.3 Configuring Wireless MAC Filter



Note:

This section applies to Access Point and WDS Access point mode.

Wireless MAC Filters are used to allow or deny network access to wireless clients according to their MAC addresses. You can manually add a MAC address to restrict the permission to access EnStation2. The default setting is Disable Wireless MAC Filters.

Wireless MAC Filter

[Home](#)
[Reset](#)

ACL Mode

: : : : : [Add](#)

#	MAC Address

[Accept](#)

ACL Mode Determines whether network access is granted or denied to clients whose MAC addresses appear in the MAC Address table on this page. Choices are Disable, Deny MAC in the list, or Allow MAC in the list.

MAC Address Filter Enter the MAC address of the device.

Click [Add](#) to add the MAC address to the MAC Address table.

Click [Apply](#) to apply the changes.

4.4.4 Configuring WDS Link Settings

Using WDS Link Settings, you can create a wireless backbone link between multiple access points that are part of the same wireless network. This allows a wireless network to be expanded using multiple Access Points without the need for a wired backbone to link them, as is traditionally required.

Security Select the type of WDS security: None, WEP, or AES.

WEP Key Enter the WEP key.

AES Passphrase Enter the AES passphrase.

MAC Address Enter the MAC address of the Access Point to which you want to extend wireless connectivity.

Mode Select Disable or Enable to disable or enable WDS.

Click **Accept** to confirm the changes or **Cancel** to cancel and return previous settings.

WDS Link Settings
Home Reset

Security	None <input type="button" value="v"/>
WEP Key	<input style="width: 80%;" type="text"/> 40/64-bit(10 hex digits) <input type="button" value="v"/>
AES Passphrase	<input style="width: 80%;" type="text"/> <small>(8-63 ASCII characters or 64 hexadecimal digits)</small>

ID	MAC Address	Mode
1	<input style="width: 15%;" type="text"/> : <input style="width: 15%;" type="text"/> : <input style="width: 15%;" type="text"/> : <input style="width: 15%;" type="text"/> : <input style="width: 15%;" type="text"/> : <input style="width: 15%;" type="text"/>	Disable <input type="button" value="v"/>
2	<input style="width: 15%;" type="text"/> : <input style="width: 15%;" type="text"/> : <input style="width: 15%;" type="text"/> : <input style="width: 15%;" type="text"/> : <input style="width: 15%;" type="text"/> : <input style="width: 15%;" type="text"/>	Disable <input type="button" value="v"/>
3	<input style="width: 15%;" type="text"/> : <input style="width: 15%;" type="text"/> : <input style="width: 15%;" type="text"/> : <input style="width: 15%;" type="text"/> : <input style="width: 15%;" type="text"/> : <input style="width: 15%;" type="text"/>	Disable <input type="button" value="v"/>
4	<input style="width: 15%;" type="text"/> : <input style="width: 15%;" type="text"/> : <input style="width: 15%;" type="text"/> : <input style="width: 15%;" type="text"/> : <input style="width: 15%;" type="text"/> : <input style="width: 15%;" type="text"/>	Disable <input type="button" value="v"/>

Accept
Cancel



Note:

The Access Point to which you want to extend wireless connectivity must enter the EnStation2's MAC address into its configuration. For more information, refer to the documentation for the Access Point. Not all Access Point supports this feature.

4.4.5 Configuring Advanced Network Settings

Configure the advanced wireless settings for your access point using the screens in this section. Leave these settings to their default values if you are not sure what values to enter.

Data Rate Select a data rate from the drop-down list. The data rate affects throughput. If you select a low data rate value, for example, the throughput is reduced but the transmission distance increases.

Transmit Power Lets you increase or decrease transmit power. Higher transmit power may prevent connections to the network, while the lower transmit power can prevent clients from connecting to the device.

RTS/CTS Threshold Specify the threshold package size for RTC/CTS. A small number causes RTS/CTS packets to be sent more often and consumes more bandwidth.

Distance Specify the distance between Access Points and clients. Longer distances may drop high-speed connections.

Aggregation Merges data packets into one packet. This option reduces the number of packets, but increases packet sizes.

Wireless Advanced Settings

Data Rate	Auto
Transmit Power	20 dBm <input type="checkbox"/> Obey Regulatory Power
RTS/CTS Threshold (1 - 2346)	2346 bytes
Distance (1-30km)	1 km
Aggregation:	<input checked="" type="radio"/> Enable <input type="radio"/> Disable 32 Frames 50000 Bytes(Max)

Wireless Traffic Shaping

Enable Traffic Shaping Enable or disable the regulation of packet flow leaving an interface for improved QoS.

Incoming Traffic Limit Specify the wireless transmission speed used for downloading.

Outgoing Traffic Limit Specify the wireless transmission speed used for uploading.

Total Percentage Specify the total percentage of the wireless traffic that is shaped.

SSID1 to SSID4 Specify the percentage of the wireless traffic that is shaped for a specific SSID.

Wireless Traffic Shaping

Enable Traffic Shaping	<input checked="" type="radio"/> Enable <input type="radio"/> Disable
Incoming Traffic Limit	1000 kbit/s (512-99999999)
Outgoing Traffic Limit	180000 kbit/s (512-99999999)
Total Percentage	10 %
SSID #1 : EnGenius1	10 %
SSID #2 : (Off)	10 %
SSID #3 : (Off)	10 %
SSID #4 : (Off)	10 %

4.5 Management Setup

The Management section lets you configure administration, management VLAN, SNMP settings, backup/restore settings, firmware upgrade, time settings, and log settings. This chapter describes these settings.

4.5.1 Configuring Administrator Account

Click the Administration link under the Management menu to change the user name and password used to log on to the EnStation2 Web Configurator. The default user name is `admin` and the default password is `admin`. Changing these settings protects the EnStation2 configuration settings from being accessed by unauthorized users.

New Name Enter a new username for logging in to the Web Configurator.

New Password Enter a new password for logging in to the Web Configurator

Confirm Password Re-enter the new password for confirmation.

Click `Save/Apply` to apply the changes or `Cancel` to return previous settings.

Login Setting		Home	Reset
New Name	admin		
New Password			
Confirm Password			
<input type="button" value="Save/Apply"/> <input type="button" value="Cancel"/> <input type="button" value="Logout"/>			

Remote Management Enable or disable remote management.

Remote Upgrade Specify whether the EnStation2 firmware can be upgraded remotely.

Remote Management Port If remote management is enabled, enter the port number to be used for remote management. For example: If you specify the port number 8080, enter `http://<IP address>:8080` to access the EnStation2 Web Configurator.

Click `Accept` to apply the changes or `Cancel` to return previous settings.

Remote Access	
Remote Management	<input checked="" type="radio"/> Enable <input type="radio"/> Disable
Remote Upgrade	<input checked="" type="radio"/> Enable <input type="radio"/> Disable
Remote Management Port	8080
<input type="button" value="Accept"/> <input type="button" value="Cancel"/>	

4.5.2 Configuring Management VLAN

Click the Management VLAN link under the Management menu to assign a VLAN tag to the packets. A VLAN is a group of computers on a network whose software has been configured so that they behave as if they were on a separate Local Area Network (LAN). Computers on VLAN do not have to be physically located next to one another on the LAN.

Management VLAN Settings

[Home](#)[Reset](#)

Caution: If you reconfigure the Management VLAN ID, you may lose connectivity to the access point. Verify that the switch and DHCP server can support the reconfigured VLAN ID, and then re-connect to the new IP address.

Management VLAN ID

 No VLAN tag Specified VLAN ID

(must be in the range 1 ~ 4094.)

[Accept](#)[Cancel](#)

Management VLAN ID If your network includes VLANs and if tagged packets need to pass through the Access Point, enter the VLAN ID. Otherwise, click No VLAN tag.

Click [Accept](#) to confirm the changes or [Cancel](#) to cancel and return previous settings.

**Note:**

If you reconfigure the Management VLAN ID, you may lose your connection to the EnStation2. Verify that the DHCP server supports the reconfigured VLAN ID and then reconnect to the EnStation2 using the new IP address.

4.5.3 Configuring SNMP

SNMP is used in network management systems to monitor network-attached devices for conditions that warrant administrative attention.

SNMP Enable or disable the EnStation2 SNMP function.

Contact Enter the contact details of the device.

Location Enter the location of the device.

Community Name (Read Only) Enter the password for accessing the SNMP community for read-only access.

Community Name (Read/Write) Enter the password for accessing the SNMP community for read and write access.

Trap Destination Address Enter the IP address where SNMP traps are to be sent.

Trap Destination Community Name Enter the password of the SNMP trap community.

SNMPv3 Enable or Disable the SNMPv3 feature.

User Name Specify the username for SNMPv3.

Auth Protocol Select the authentication protocol type: MD5 or SHA.

Auth Key (8-32 Characters) Specify the authentication key for authentication.

Priv Protocol Select the privacy protocol type: DES.

Priv Key (8-32 Characters) Specify the privacy key for privacy.

SNMP Settings		Home	Reset
SNMP	<input checked="" type="radio"/> Enable <input type="radio"/> Disable		
Contact	<input type="text"/>		
Location	<input type="text"/>		
Community Name (Read Only)	public		
Community Name (Read/Write)	private		
Trap Destination Address	<input type="text"/>		
Trap Destination Community Name	public		
SNMPv3	<input checked="" type="radio"/> v3Enable <input type="radio"/> v3Disable		
User Name	admin		
Auth Protocol	MD5		
Auth Key (8-32 Characters)	12345678		
Priv Protocol	DES		
Priv Key (8-32 Characters)	12345678		
Engine ID	<input type="text"/>		
<input type="button" value="Save/Apply"/> <input type="button" value="Cancel"/>			

Engine ID Specify the engine ID for SNMPv3.

Click *Save/Apply* to apply the changes or *Cancel* to return previous settings.

4.5.4 Configuring Backup/Restore Settings

Click the Backup/Restore Setting link under the Management menu to save the EnStation2's current settings in a file on your local disk or load settings onto the device from a local disk. This feature is particularly convenient administrators who have several EnStation2 devices that need to be configured with the same settings.

This page also lets you return the EnStation2 to its factory default settings. If you perform this procedure, any changes made to the EnStation2 default settings will be lost.

Backup/Restore Settings

[Home](#)[Reset](#)

Save A Copy of Current Settings

Restore Saved Settings from A File

 No file chosen

Revert to Factory Default Settings

Save A Copy of Current Settings Click `Backup` to save the current configured settings.

Restore Saved Settings from A File To restore settings that have been previously backed up, click `Browse`, select the file, and click `Restore`.

Revert to Factory Default Settings Click `Factory Default` to restore the EnStation2 to its factory default settings.

4.5.5 Configuring Auto Reboot Settings

Click the Auto Reboot Settings link under the Management menu to enable or disable the Auto Reboot function. This feature is particularly convenient to administrators for the scheduling of auto rebooting on the device.

This page also allows you to set the frequency of this function.

Auto Reboot Settings

[Home](#) [Reset](#)

Auto Reboot Setting	Disable ▾
Frequency of Auto Reboot	Min ▾ 10 Mins ▾

[Save/Apply](#) [Cancel](#)

Auto Reboot Setting Select `Enable` from the drop-down menu to setup this function.

Frequency of Auto Reboot Select the frequency interval using the drop-down menus.

Save/Apply Click `Save/Apply` to set the new configuration.

Cancel Click `Cancel` to delete the settings.

4.5.6 Configuring Firmware Upgrade

Firmware is system software that operates and allows the administrator to interact with the router.



WARNING!

Upgrading firmware through a wireless connection is not recommended. Firmware upgrading must be performed while connected to an Ethernet (LAN port) with all other clients disconnected.

The firmware upgrade procedure can take several minutes. Do not power off the EnStation2 during the firmware upgrade, as it can cause the device to crash or become unusable.

To update the firmware version, follow these steps:

1. Download the appropriate firmware approved by EnGenius Networks from an approved web site.



Note:

Save the firmware file to a local hard drive.

2. Click `Choose File`.
3. Browse the file system and select the firmware file.
4. Click `Upload`.
5. The EnStation2 restarts automatically after the upgrade completes.

Firmware Upgrade

Current firmware version: 1.1.13

Locate and select the upgrade file from your hard disk:

No file chosen

4.5.7 Configuring System Time

Change the system time of the EnStation2 by manually entering the information, synchronizing the device with a PC, or setup automatic updates through a network time (NTP) protocol server.

Manually Set Date and Time Enter the date and time values in the date and time fields or click the *Synchronize with PC* button to get the date and time values from the administrator's PC.

Automatically Get Date and Time Select a time zone from the drop-down list and check whether you want to enter the IP address of an NTP server or use the default NTP server.

Enable Daylight Saving Click to enable or disable daylight savings time. Select the start and stop times from the *Start Time* and *Stop Time* dropdown lists.

Click *Save/Apply* to apply the changes or *Cancel* to return previous settings.

Time Settings

The screenshot shows the 'Time Settings' configuration window. It has a title bar 'Time Settings' and a main area with a blue header 'Time'. There are three radio buttons: 'Manually Set Date and Time' (unselected), 'Automatically Get Date and Time' (selected), and 'Enable Daylight Saving' (unselected). Under 'Manually Set Date and Time', there are input fields for year (2012), month (08), day (31), hour (09), and minute (36), and a 'Synchronize with PC' button. Under 'Automatically Get Date and Time', there is a 'Time Zone' dropdown menu showing 'UTC+00:00 Gambia, Liberia, Morocco' and a 'User defined NTP Server' input field with '209.81.9.7'. Under 'Enable Daylight Saving', there are 'Start Time' and 'End Time' sections, each with dropdowns for month, day, and time. The 'Start Time' is set to January 1st at 12 am, and the 'End Time' is set to January 1st at 12 am. At the bottom, there are 'Save/Apply' and 'Cancel' buttons.

4.5.8 Configuring Wi-Fi Schedule

Use the Wi-Fi schedule function to control the wireless power ON/OFF service that operates on a routine basis.

Add a Schedule Service

Create a schedule service type and date/time parameters for a specific service.

Schedule Name Enter the description of the schedule service.

Service Select the type of schedule service, either Wireless Power ON or Wireless Power OFF.

Day Select the days of the week to enable the schedule service.

Time of Day Set the start time that the service is active.

Click **Add** to append the schedule service to the schedule service table, or **Cancel** to discard changes.

Wifi Schedule

Wifi Schedule	Disable ▾
Schedule Name	<input type="text"/>
Service	<input checked="" type="radio"/> Wireless Power ON <input type="radio"/> Wireless Power OFF
Day	Mon ▾
Time of day	<input type="text"/> : <input type="text"/> (use 24-hour clock)
<input type="button" value="Add"/> <input type="button" value="Cancel"/>	

Schedule Services Table

The Schedule function relies on the GMT time setting acquired from a network time protocol (NTP) server. For details on how to connect the EnStation2 to an NTP server, see *Configuring System Time*.

Schedule Table

#	Name	Service	Schedule	Select
<input type="button" value="Delete Selected"/> <input type="button" value="Delete All"/> <input type="button" value="Reset"/>				
<hr/> <input type="button" value="Accept"/> <input type="button" value="Cancel"/>				

Schedule Table Displays a list of scheduled services for the EnStation2. The properties of each service displayed are:

Displays the ID number of the service in the table.

Name Displays the description of the service.

Service Displays the type of service, either `Wireless Power ON` or `Wireless Power OFF`.

Schedule Displays the schedule information of when the service is active.

Select Select one or more services to edit or delete.

Click `Delete Selected` to delete the selected services or `Delete All` to delete all services.

Click `Apply` to save the settings or `Cancel` to discard changes.

4.5.9 Configuring Command Line Interface

Most users will configure the EnStation2 through the graphical user interface (GUI). However, for those who prefer an alternative method there is the command line interface (CLI). The CLI can be accessed through a command console, modem or Telnet connection.

CLI Select to enable or disable the ability to modify the EnStation2 via a command line interface (CLI).

Click *Save/Apply* to apply the changes or *Cancel* to return previous settings.

CLI Setting

CLI	<input checked="" type="radio"/> ON <input type="radio"/> OFF
<input type="button" value="Save/Apply"/>	<input type="button" value="Cancel"/>

4.5.10 Configuring Logging

Display a list of events that are triggered on the EnStation2 Ethernet and wireless interfaces. You can consult this log if an unknown error occurs on the system or when a report needs to be sent to the technical support department for debugging purposes.

Syslog Enable or disable the EnStation2 syslog function.

Log Server IP Address Enter the IP address of the log server.

Local Log Enable or disable the local log service.

Click *Save/Apply* to apply the changes or *Cancel* to return previous settings.

Log

Syslog

Syslog	Disable ▾
Log Server IP Address / Computer Name	0.0.0.0

Local log

Local Log	Enable ▾
-----------	----------

4.5.11 Configuring Diagnostics

The diagnosis feature allow the administrator to verify that another device is available on the network and is accepting request packets. If the ping result returns `alive`, it means a device is on line. This feature does not work if the target device is behind a firewall or has security software installed.

Target IP / Domain Name Enter the IP address you would like to search.

Ping Packet Size Enter the packet size of each ping.

Number of Pings Enter the number of times you want to ping.

Start Ping Click `Start Ping` to begin pinging.

Trace route target Enter an IP address or domain name you want to trace.

Start Traceroute Click `Start Traceroute` to begin the traceroute operation.

Target Address Enter the IP address of the target PC.

Time period Enter time period for the speed test.

Check Interval Enter the interval for the speed test.

Start Speed Test Click `Start Speed Test` to begin the speed test operation.

IPv4 Port Displays the IPv4 port number of the EnStation2.

IPv6 Port Displays the IPv6 port number of the EnStation2.

Diagnostics

Ping Test Parameters

Target IP / Domain Name	<input type="text"/>
Ping Packet Size	<input type="text" value="64"/> Bytes
Number of Pings	<input type="text" value="4"/>

Traceroute Test Parameters

Traceroute target	<input type="text"/>
-------------------	----------------------

Speed Test

Target Address	<input type="text"/>
Time period	<input type="text" value="20"/> Sec
Check Interval	<input type="text" value="5"/> Sec
IPv4 Port	5001
IPv6 Port	5002

4.5.12 Viewing Device Discovery

Device Discovery

Device Name	Operation Mode	IP Address	System MAC Address	Firmware Version
-------------	----------------	------------	--------------------	------------------

Refresh

Device Name Displays the name of the devices connected to the network.

Operation Mode Displays the operation mode of the devices connected to the network.

IP Address Displays the IP address of the devices connected to the network.

System MAC Address Displays the system MAC address of the devices connected to the network.

Firmware Version Displays the firmware version of the devices connected to the network.

4.5.13 Configure Denial of Service Protection

Use TCP SYN Cookies Protection Click to enable TCP SYN cookies protection.

SYN Flood Attack Protection Click to enable or disable SYN Flood Attack Protection.

Match Interval Per Second Enter the allowed number of packets per second.

Limit Packets Enter the maximum number of packets allowed per request.

UDP Flood Attack Protection Click to enable or disable UDP Flood Attack Protection.

Match Interval Per Second Enter the allowed number of packets per second.

Limit Packets Enter the maximum number of packets allowed per request.

Ping Attack Protection Click to enable or disable ping attack protection.

Click *Save/Apply* to apply the changes or *Cancel* to return previous settings.

Dos Protection

<input type="checkbox"/> Use TCP SYN Cookies Protection	
SYN Flood Attack Protection	<input type="radio"/> Enable <input checked="" type="radio"/> Disable Match Interval <input type="text" value="50"/> Per Second Limit <input type="text" value="5"/> Packets
UDP Flood Attack Protection	<input type="radio"/> Enable <input checked="" type="radio"/> Disable Match Interval <input type="text" value="50"/> Per Second Limit <input type="text" value="5"/> Packets
Ping Attack Protection	<input type="radio"/> Enable <input checked="" type="radio"/> Disable
<input type="button" value="Save/Apply"/> <input type="button" value="Cancel"/>	

4.5.14 Logging Out

Click `Logout` to logout from the EnStation2.

Management

- Administration
- SNMP Settings
- Backup/Restore Settings
- Auto Reboot Settings
- Firmware Upgrade
- Time Settings
- Wifi Schedule
- CLI Settings
- Log
- Diagnostics
- Device Discovery
- Logout

Appendix A

Federal Communication Commission Interference Statement

This device complies with Part 15 of the FCC Rules. Operation is subject to the following two conditions: (1) This device may not cause harmful interference, and (2) this device must accept any interference received, including interference that may cause undesired operation.

This equipment has been tested and found to comply with the limits for a Class B digital device, pursuant to Part 15 of the FCC Rules. These limits are designed to provide reasonable protection against harmful interference in a residential installation. This equipment generates, uses and can radiate radio frequency energy and, if not installed and used in accordance with the instructions, may cause harmful interference to radio communications. However, there is no guarantee that interference will not occur in a particular installation. If this equipment does cause harmful interference to radio or television reception, which can be determined by turning the equipment off and on, the user is encouraged to try to correct the interference by one of the following measures:

- Reorient or relocate the receiving antenna.
- Increase the separation between the equipment and receiver.
- Connect the equipment into an outlet on a circuit different from that to which the receiver is connected.
- Consult the dealer or an experienced radio/TV technician for help.

FCC Caution: Any changes or modifications not expressly approved by the party responsible for compliance could void the user's authority to operate this equipment.

This transmitter must not be co-located or operating in conjunction with any other antenna or transmitter.

Radiation Exposure Statement:

This equipment complies with FCC radiation exposure limits set forth for an uncontrolled environment. This equipment should be installed and operated with minimum distance 24cm between the radiator & your body.











Appendix B









Europe – EU Declaration of Conformity

This device complies with the essential requirements of the R&TTE Directive 1999/5/EC. The following test methods have been applied in order to prove presumption of conformity with the essential requirements of the R&TTE Directive 1999/5/EC:

- EN60950-1
Safety of Information Technology Equipment
- EN50385
Generic standard to demonstrate the compliance of electronic and electrical apparatus with the basic restrictions related to human exposure to electromagnetic fields (0 Hz - 300 GHz)
- EN 300 328
Electromagnetic compatibility and Radio spectrum Matters (ERM); Wideband Transmission systems; Data transmission equipment operating in the 2,4 GHz ISM band and using spread spectrum modulation techniques; Harmonized EN covering essential requirements under article 3.2 of the R&TTE Directive
- EN 301 489-1
Electromagnetic compatibility and Radio Spectrum Matters (ERM); ElectroMagnetic Compatibility (EMC) standard for radio equipment and services; Part 1: Common technical requirements
- EN 301 489-17
Electromagnetic compatibility and Radio spectrum Matters (ERM); ElectroMagnetic Compatibility (EMC) standard for radio equipment and services; Part 17: Specific conditions for 2,4 GHz wideband transmission systems and 5 GHz high performance RLAN equipment

C €0560

 Český [Czech]	<i>[Jméno výrobce]</i> tímto prohlašuje, že tento <i>[typ zařízení]</i> je ve shodě se základními požadavky a dalšími příslušnými ustanoveními směrnice 1999/5/ES.
 Dansk [Danish]	Undertegnede <i>[fabrikantens navn]</i> erklærer herved, at følgende udstyr <i>[udstyrets typebetegnelse]</i> overholder de væsentlige krav og øvrige relevante krav i direktiv 1999/5/EF.
 Deutsch [German]	Hiermit erkläre <i>[Name des Herstellers]</i> , dass sich das Gerät <i>[Gerätetyp]</i> in Übereinstimmung mit den grundlegenden Anforderungen und den übrigen einschlägigen Bestimmungen der Richtlinie 1999/5/EG befindet.
 Eesti [Estonian]	Käesolevaga kinnitab <i>[tootja nimi = name of manufacturer]</i> seadme <i>[seadme tüüp = type of equipment]</i> vastavust direktiivi 1999/5/EÜ põhinõuetele ja nimetatud direktiivist tulenevatele teistele asjakohastele sätetele.
 English	Hereby, <i>[name of manufacturer]</i> , declares that this <i>[type of equipment]</i> is in compliance with the essential requirements and other relevant provisions of Directive 1999/5/EC.
 Español [Spanish]	Por medio de la presente <i>[nombre del fabricante]</i> declara que el <i>[clase de equipo]</i> cumple con los requisitos esenciales y cualesquiera otras disposiciones aplicables o exigibles de la Directiva 1999/5/CE.
 Ελληνική [Greek]	ΜΕ ΤΗΝ ΠΑΡΟΥΣΑ <i>[name of manufacturer]</i> ΔΗΛΩΝΕΙ ΟΤΙ <i>[type of equipment]</i> ΣΥΜΜΟΡΦΩΝΕΤΑΙ ΠΡΟΣ ΤΙΣ ΟΥΣΙΩΔΕΙΣ ΑΠΑΙΤΗΣΕΙΣ ΚΑΙ ΤΙΣ ΛΟΙΠΕΣ ΣΧΕΤΙΚΕΣ ΔΙΑΤΑΞΕΙΣ ΤΗΣ ΟΔΗΓΙΑΣ 1999/5/ΕΚ.
 Français [French]	Par la présente <i>[nom du fabricant]</i> déclare que l'appareil <i>[type d'appareil]</i> est conforme aux exigences essentielles et aux autres dispositions pertinentes de la directive 1999/5/CE.
 Italiano [Italian]	Con la presente <i>[nome del costruttore]</i> dichiara che questo <i>[tipo di apparecchio]</i> è conforme ai requisiti essenziali ed alle altre disposizioni pertinenti stabilite dalla direttiva 1999/5/CE.
 Latviski [Latvian]	Ar šo <i>[name of manufacturer / izgatavotāja nosaukums]</i> deklarē, ka <i>[type of equipment / iekārtas tips]</i> atbilst Direktīvas 1999/5/EK būtiskajām prasībām un citiem ar to saistītajiem noteikumiem.

Lietuvių [Lithuanian]	Šiuo <i>[manufacturer name]</i> deklaruoja, kad šis <i>[equipment type]</i> atitinka esminius reikalavimus ir kitas 1999/5/EB Direktyvos nuostatas.
 Nederlands [Dutch]	Hierbij verklaart <i>[naam van de fabrikant]</i> dat het toestel <i>[type van toestel]</i> in overeenstemming is met de essentiële eisen en de andere relevante bepalingen van richtlijn 1999/5/EG.
 Malti [Maltese]	Hawnhekk, <i>[isem tal-manifattur]</i> , jiddikjara li dan <i>[il-mudel tal-prodott]</i> jikkonforma mal-ħtiġijiet essenzjali u ma provvedimenti oħrajn relevanti li hemm fid-Dirrettiva 1999/5/EC.
 Magyar [Hungarian]	Alulírott, <i>[gyártó neve]</i> nyilatkozom, hogy a <i>[... típus]</i> megfelel a vonatkozó alapvető követelményeknek és az 1999/5/EC irányelv egyéb előírásainak.
 Polski [Polish]	Niniejszym <i>[nazwa producenta]</i> oświadczam, że <i>[nazwa wyrobu]</i> jest zgodny z zasadniczymi wymogami oraz pozostałymi stosownymi postanowieniami Dyrektywy 1999/5/EC.
 Português [Portuguese]	<i>[Nome do fabricante]</i> declara que este <i>[tipo de equipamento]</i> está conforme com os requisitos essenciais e outras disposições da Directiva 1999/5/CE.
 Slovensko [Slovenian]	<i>[Ime proizvajalca]</i> izjavlja, da je ta <i>[tip opreme]</i> v skladu z bistvenimi zahtevami in ostalimi relevantnimi določili direktive 1999/5/ES.
Slovensky [Slovak]	<i>[Meno výrobcu]</i> týmto vyhlasuje, že <i>[typ zariadenia]</i> spĺňa základné požiadavky a všetky príslušné ustanovenia Smernice 1999/5/ES.
 Suomi [Finnish]	<i>[Valmistaja = manufacturer]</i> vakuuttaa täten että <i>[type of equipment = laitteen tyyppimerkintä]</i> tyyppinen laite on direktiivin 1999/5/EY oleellisten vaatimusten ja sitä koskevien direktiivin muiden ehtojen mukainen.
 Svenska [Swedish]	Härmed intygar <i>[företag]</i> att denna <i>[utrustningstyp]</i> står i överensstämmelse med de väsentliga egenskapskrav och övriga relevanta bestämmelser som framgår av direktiv 1999/5/EG.

Appendix C

WorldWide Technical Support

REGION/COUNTRY OF PURCHASE	SERVICE CENTRE	SERVICE INFORMATION	
Canada	CANADA	web site	www.engeniuscanada.com
		email	rma@engeniuscanada.com
		contact numbers	Toll Free: (+1) 888-397-2788 Local: (+1) 905-940-8181
		hours of operation	Monday - Friday 9:00AM to 5:30PM EST (GMT-5)
USA	LOS ANGELES, USA	web site	www.engiustech.com
		email	support@engiustech.com
		contact numbers	Toll Free: (+1) 888-735-7888 Local: (+1) 714-432-8668
		hours of operation	Monday - Friday 8:00 AM to 4:30 PM PST (GMT-8)

REGION/COUNTRY OF PURCHASE	SERVICE CENTRE		SERVICE INFORMATION
Mexico, Central and Southern America	MIAMI, USA	web site	[ES] es.engeniustech.com [PT] pg.engeniustech.com
		email	miamisupport@engeniustech.com
		contact numbers	Miami: (+1) 305-887-7378 Sao Paulo, Brazil: (+55)11-3957-0303 D.F., Mexico:(+52)55-1163-8894
		hours of operation	Monday - Friday 8:00 AM to 5:30PM EST (GMT-5)
Europe	NETHERLANDS	web site	www.engeniusnetworks.eu
		email	support@engeniusnetworks.eu
		contact numbers	(+31) 40-8200-887
		hours of operation	Monday - Friday 9:00 AM - 5:00 PM (GMT+1)
Africa Middle East Russia CIS / Armenia, Azerbaijan, Belarus, Georgia, Kazakhstan, Kyrgyzstan, Moldova, Tajikistan, Turkmenistan, Ukraine, Uzbekistan Turkey Afghanistan Pakistan Bangladesh, Maldives, Nepal, Bhutan, Sri Lanka	DUBAI, UAE	web site	www.engenius-me.com
		email	support@engenius-me.com
		contact numbers	Toll Free: U.A.E.: 800-EnGenius 800-364-364-87 General: (+971) 4357-5599
		hours of operation	Sunday - Thursday 9:00 AM - 6:00 PM (GMT+4)

REGION/COUNTRY OF PURCHASE	SERVICE CENTRE	SERVICE INFORMATION	
Singapore, Cambodia, Indonesia, Malaysia, Thailand, Philippines, Vietnam China, Hong Kong, Korea India South Africa Oceania	SINGAPORE	web site	www.engeniustech.com.sg/e_warranty_form
		email	techsupport@engeniustech.com.sg
		contact numbers	Toll Free: Singapore: 1800-364-3648
		hours of operation	Monday - Friday 9:00 AM - 6:00 PM (GMT+8)
Others	TAIWAN, R.O.C.	web site	www.engeniusnetworks.com
		email	technology@senao.com

Note:

* Service hours are based on the local time of the service center.

* Please visit the website for the latest information about customer service.